

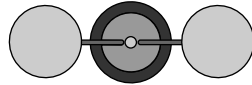



- *Armatürün Fener kısmı;
- Konik yapıdadır.
- Kenar çıtalar ve boru adaptörleri döküm alüminyumdan üretilmi tir.
- apka kısmındaki süs motifleri alüminyum levhadan ekillenmi tir.
- *Alt tabanı ve süs vazosu döküm alüminyumdan üretilmi tir.
- * Sigorta ve Ba lantı Terminali alt gövde borusunun içine montajlıdır.
- * Terminal Kapa ı Sıfır kesitli ve su geçirmez contalıdır.
- * Elektro Galvanizli Çelikten üretilen Zemin Montaj Elemanı, Flan lı ve 3 Blondan olu maktadır.
- * Kullanılan tüm vidalar paslanmaz çeliktendir.
- * Dı etkenlere kar ı dayanıklı Antibulle katkılı, Elektrostatik Polyester Toz Boyalıdır.
- * ste e ba lı tüm RAL renkler kullanılabilir.

- *The lantern part of the armature;
- Conic Shaped,
- Side slats and pole adapters are manufactured from cast aluminium.
- Decorative motifs on the cap are shaped from aluminum plaster.
- *Base and decorative vase is manufactured from cast aluminum.
- * The connection terminal and Fuse Box are mounted into the lower side of the body pole.
- * Terminal cover has zero section with the water resist gasket.
- * Ground Mounting Element is made of Galvanized Steel with three anchor bolts and flange.
- * All screws are made of stainless steel.
- * The Paint is Electrostatic Polyester with The Antibulle alloyed resistant to all external factors.
- * All RAL Colours can be applied upon request.



D 430-2

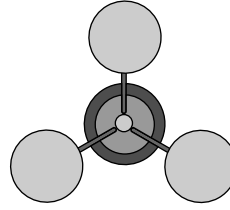

D 430-3

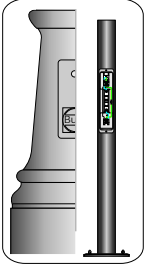

D 430-2

5000mm

3700mm

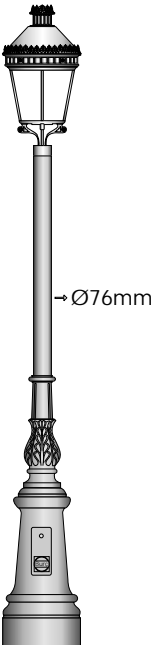
 D 430
380mm

Ø76mm

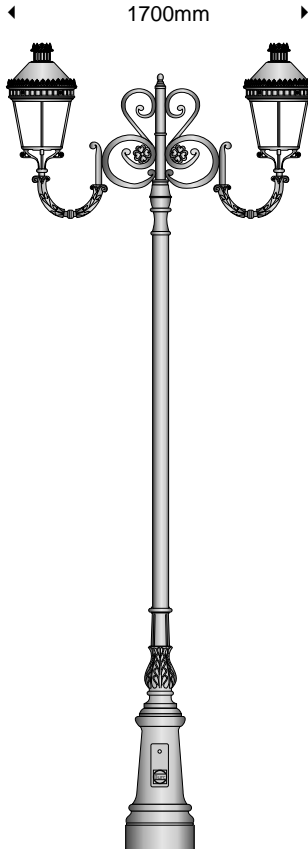

1700mm

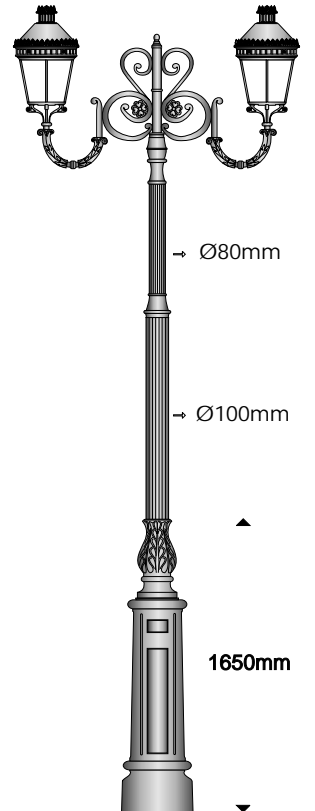
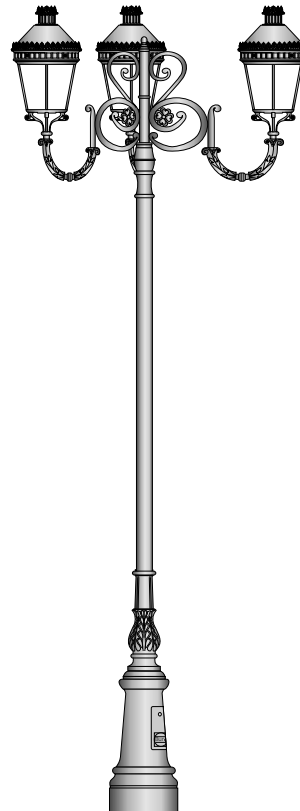

Ø80mm

Ø100mm

1650mm

400mm

Armatür Dekoratif Tabanı

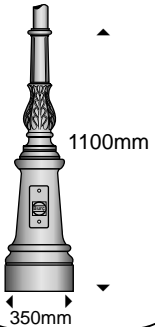

1100mm

350mm

IP.55.



ISO 9001:2000

 MONTAJ
ELEMANI

 HPL-Comf. 50W
HPL-Comf. 80W
HPL-Comf.125W

 SON-E 50W
SON-E 70W

 Özel Alüminyum Taban
Special Aluminum Base